

Article number: 3902150023350

Description: Worm gear
VF 150-V-23-132B5, without lubrication

Measures

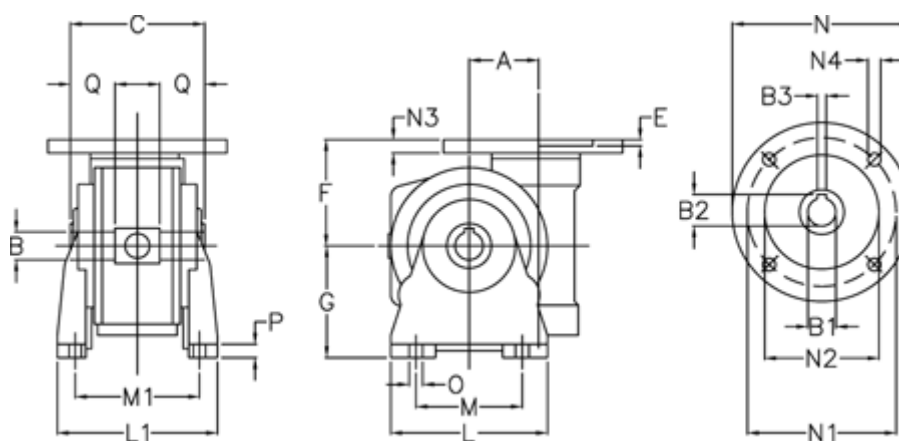

A = 150	G = 220	N3 = 16
B = 50 H7	L = 330	N4 = 13
B1 E7 = 38	L1 = 260	O = 18
B2 = 41.3	M = 240	P = 20
B3 H9 = 10	M1 = 211	Q = 55
C = 175	N = 300	
E = 2	N1 = 265	
F = 190	N2 = 230	